

# ASSEMBLY INSTRUCTIONS

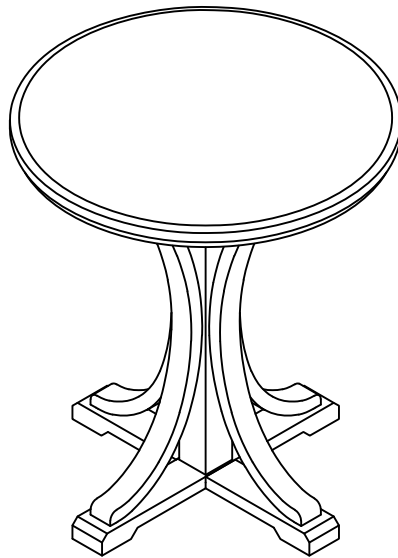

## FATIMA ROUND ACCENT TABLE



### Please read below before assembly:

- Assemble the product on a flat, soft surface such as a carpet or cloth to prevent scratching the finish.
- Do not discard any content until assembly is complete to avoid accidentally discarding small parts or hardware.
- Take out all parts and hardware from box.
- Failure to follow these instructions may cause the bolts to misalign during assembly.

### DISCLAIMERS:

- WHEN PROPERLY ASSEMBLED, THIS ITEM IS SAFE FOR INTENDED USE. SELLER IS NOT LIABLE FOR ANY DAMAGES RESULTING FROM ITEM BEING IMPROPERLY ASSEMBLED AFTER PURCHASE.
- BOLTS MAY LOOSEN DURING NORMAL EVERYDAY USE. THEY SHOULD BE INSPECTED AT LEAST EVERY 3 MONTHS AND RE-TIGHTEN AS NEEDED TO PREVENT DAMAGE OR INJURY, AND ENSURE STABILITY.



PEOPLE NEEDED

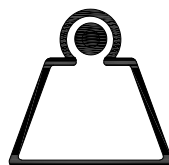



75  
lbs top

WEIGHT LIMIT





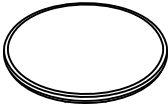
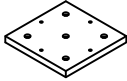
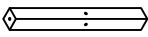

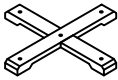
ESTIMATED TIME

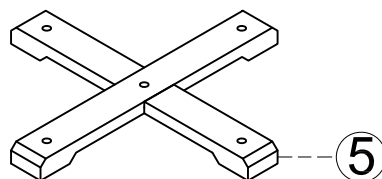
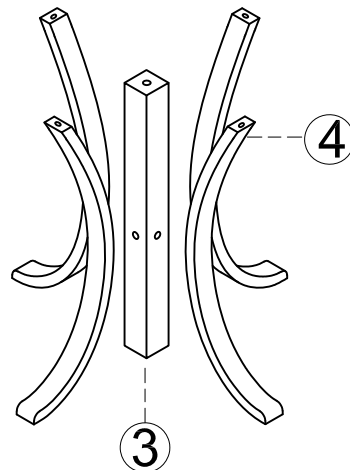
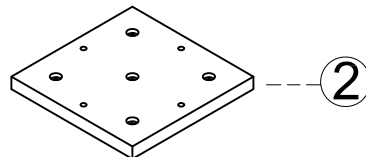
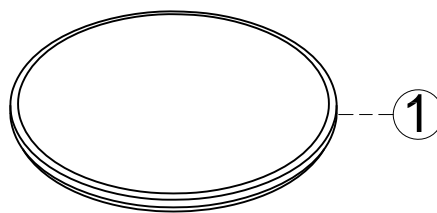
# PARTS LIST

①	TABLE TOP		1 PC
②	MOUNTING PLATE		1 PC
③	POST		1 PC
④	LEG		4 PCS
⑤	BOTTOM FRAME		1 PC



# HARDWARE LIST

A	BOLT - Ø1/4"x1-1/2"		2 PCS
B	BOLT - Ø1/4"x1-1/4"		12 PCS
C	LOCK WASHER - Ø1/4"		14 PCS
D	FLAT WASHER - Ø1/4"		14 PCS
D	ALLEN KEY - 1/4"		1 PC



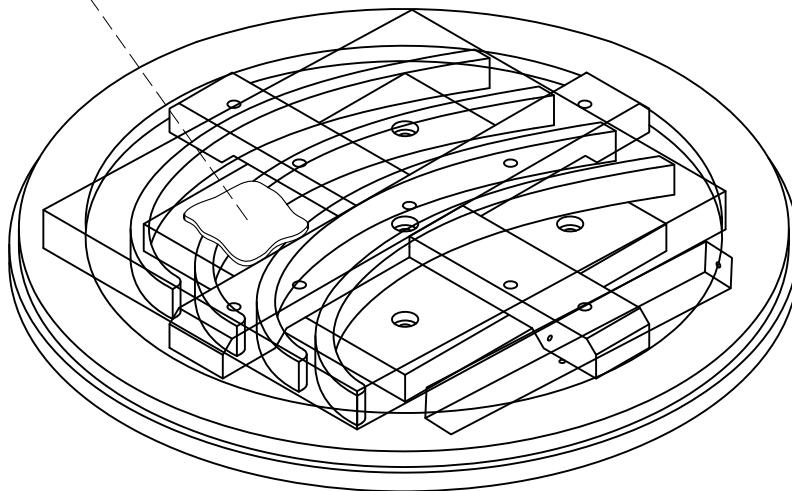

## STEP 1

LOCATE PARTS AND HARDWARE PER BELOW DRAWING.

HARDWARE





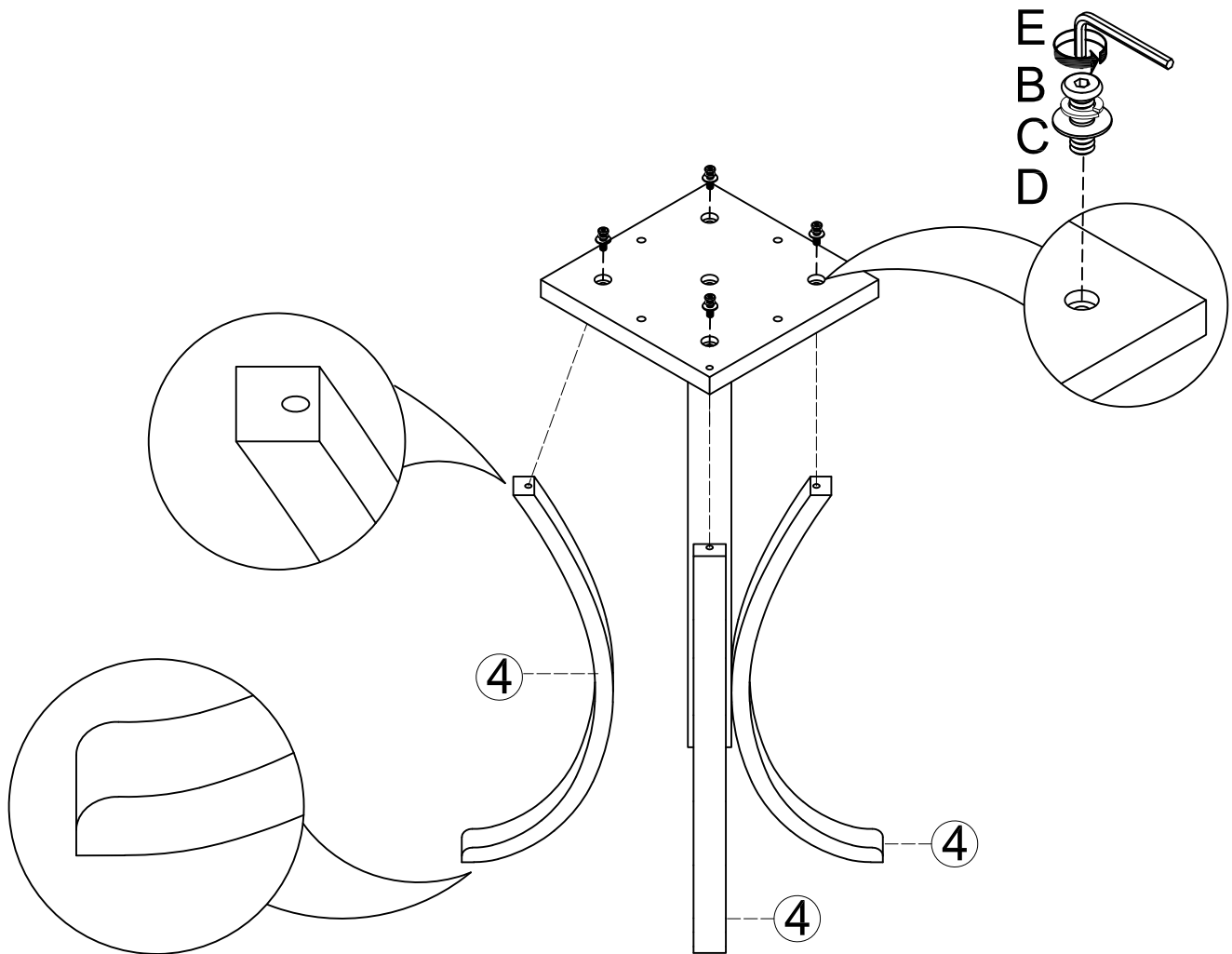
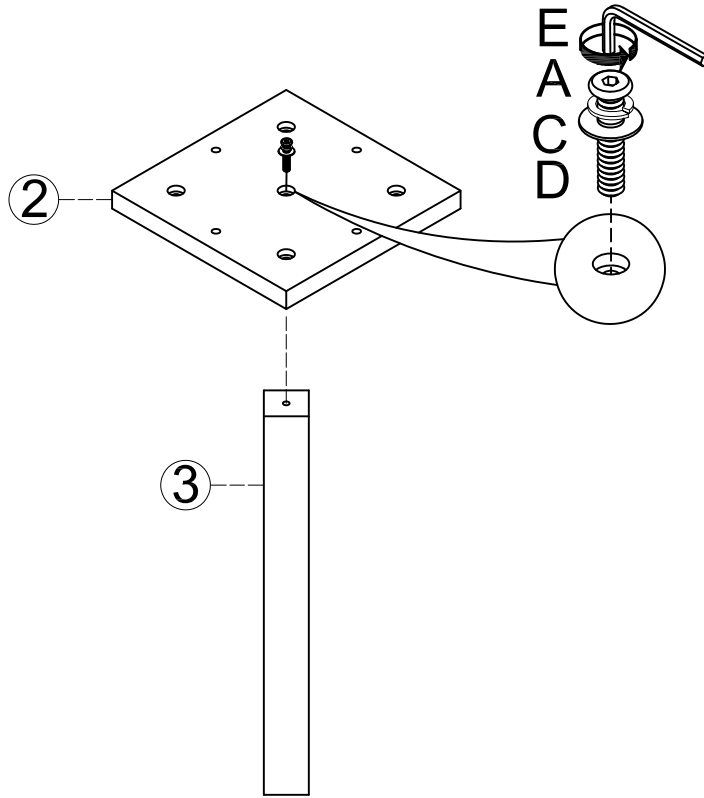

# STEP 2

A		1 PC
B		4 PCS
C		5 PCS
D		5 PCS
E		1 PC





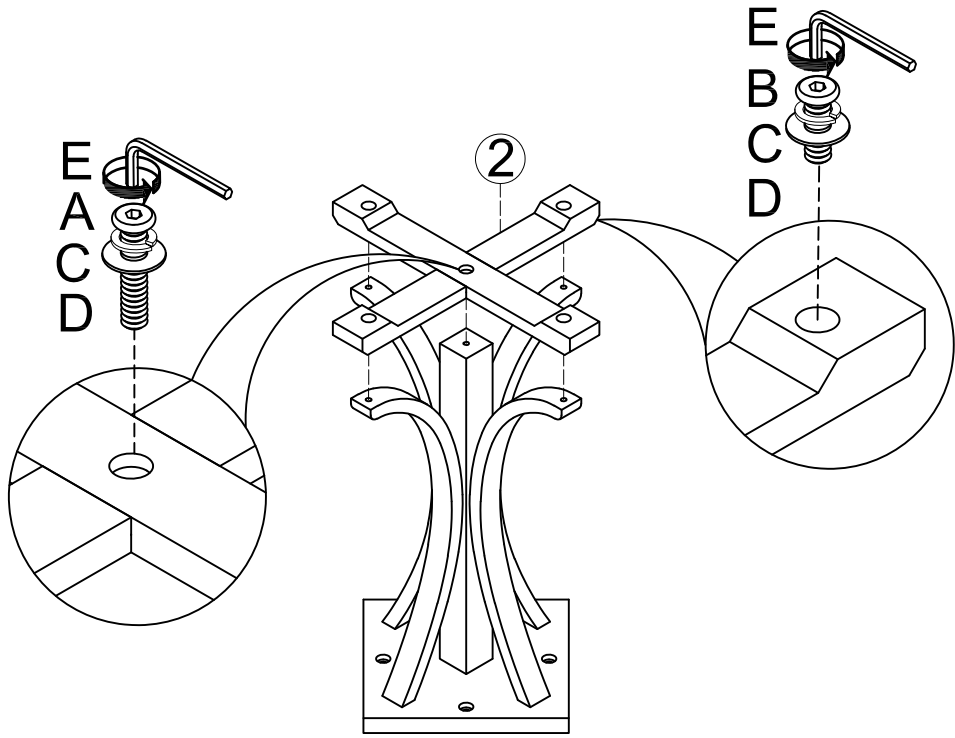

AFTER ALL LEGS ARE ALIGN WITH THE POST, TIGHTEN THE BOLTS.

# STEP 3

A		1 PC
B		4 PCS
C		5 PCS
D		5 PCS
E		1 PC





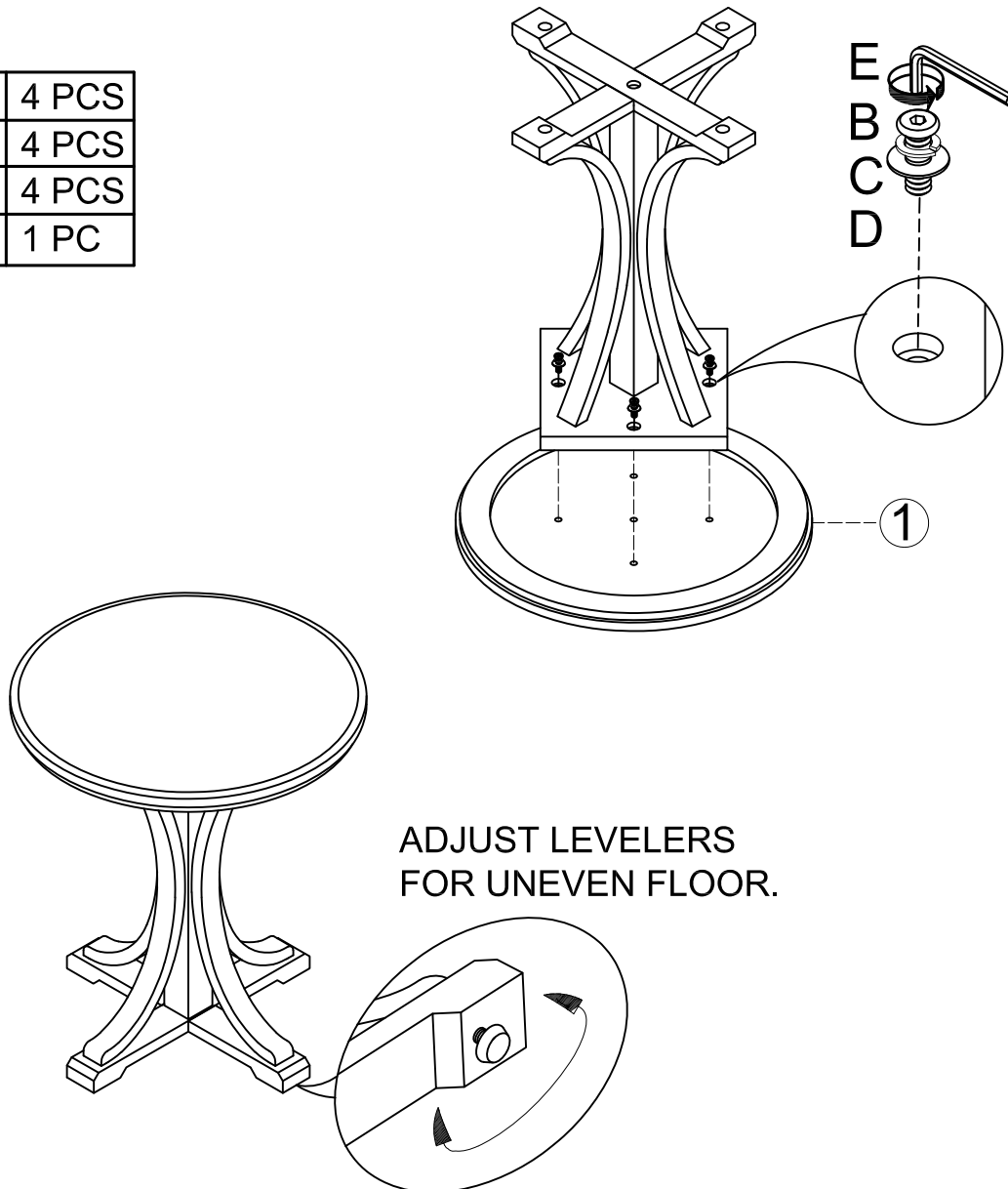

# STEP 4

B		4 PCS
C		4 PCS
D		4 PCS
E		1 PC





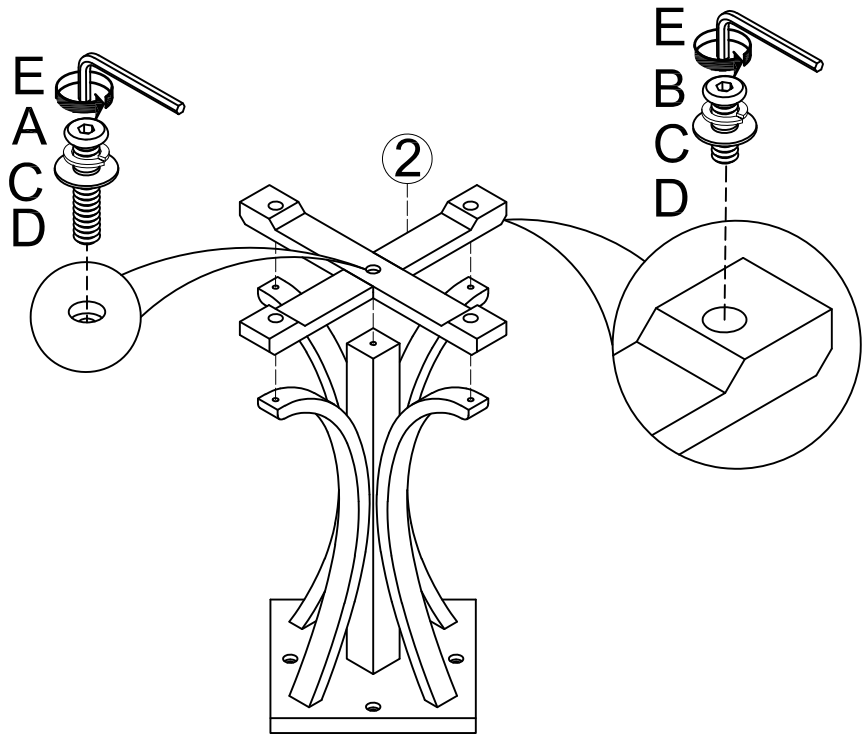

# STEP 3

A		1 PC
B		4 PCS
C		5 PCS
D		5 PCS
E		1 PC



# STEP 4

B		4 PCS
C		4 PCS
D		4 PCS
E		1 PC

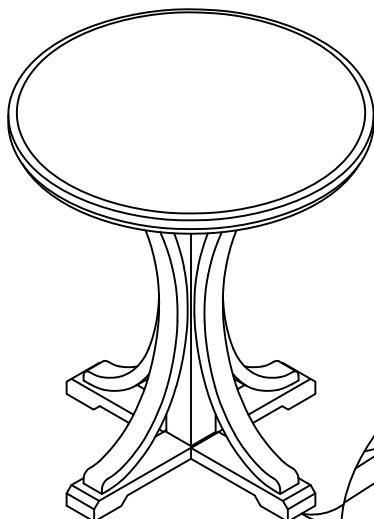
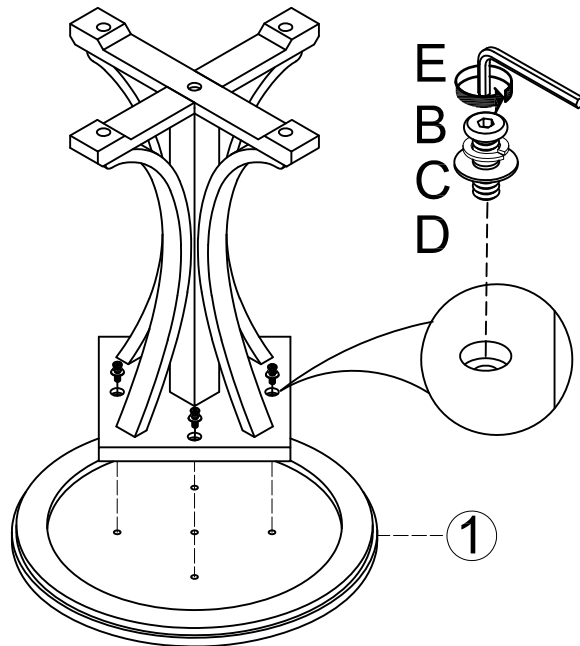

ADJUST LEVELERS  
FOR UNEVEN FLOOR.

