

ASSEMBLY INSTRUCTIONS

Description: Marbury Side Table



Important safety instructions:

- Please read carefully all instructions before assembly.
- For your safety and ease, assembly by two or more adults is recommended.
- Keep instructions for future use.





Pre-assembly:

- Do not discard any content until assembly is complete to avoid accidentally discarding small parts or hardware.
- Take out all parts and hardware from box.

Parts List

Item	Description	QTY
P1	Top Panel 	1
P2	Metal Base 	1

Hardware List

Item	Description	QTY
H1	Bolts $\varnothing 1/4" \times 5/8"$ 	4
H2	Spring Washers $\varnothing 1/4"$ 	4
H3	Flat Washers $\varnothing 1/4"$ 	4
H4	Allen Wrench 4mm 	1

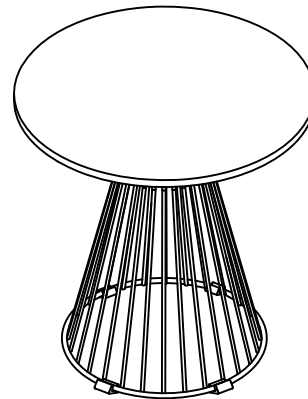

DISCLAIMER:

WHEN PROPERLY ASSEMBLED, THIS ITEM IS SAFE FOR INTENDED USE. SELLER IS NOT LIABLE FOR ANY DAMAGES RESULTING FROM ITEM BEING IMPROPERLY ASSEMBLED AFTER PURCHASE.

Assembly Procedures:

1. Turn the table top upside down on a flat, soft surface such as a carpet or cloth to prevent scratching the finish.
 - 1) Attach the metal base (P2) to the top panel (P1) as shown below. Securely tighten all bolts with Allen wrench (H4).
 - 2) Turn the assembled table to an upright position, assembly is complete.

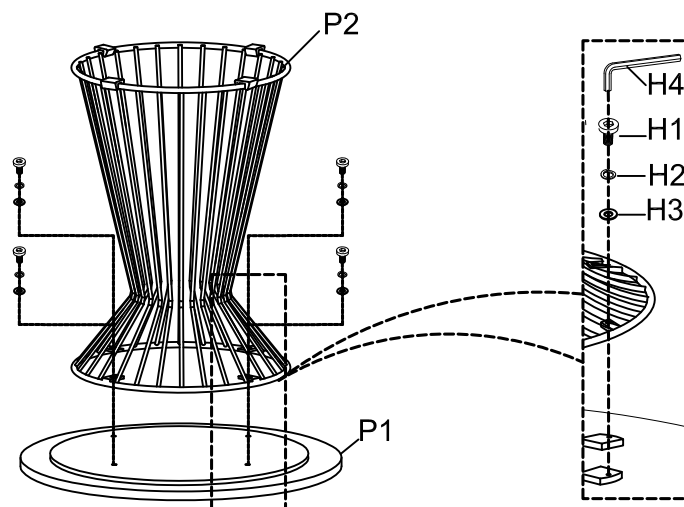

ADDITIONAL NOTE ABOUT SAFETY:

BOLTS MAY LOOSEN DURING NORMAL EVERYDAY USE.

THEY SHOULD BE INSPECTED AT LEAST EVERY 3 MONTHS AND RE-TIGHTENED AS NEEDED TO PREVENT DAMAGE OR INJURY, AND ENSURE STABILITY.

Thank you for your purchase