

ASSEMBLY INSTRUCTIONS

Description: Wilson Coffee Table





Important safety instructions:

- Please read carefully all instructions before assembly.
- For your safety and ease, assembly by two or more adults is recommended.
- Keep instructions for future use.

Pre-assembly:



- Do not discard any content until assembly is complete to avoid accidentally discarding small parts or hardware.
- Take out all parts and hardware from box.

Parts List

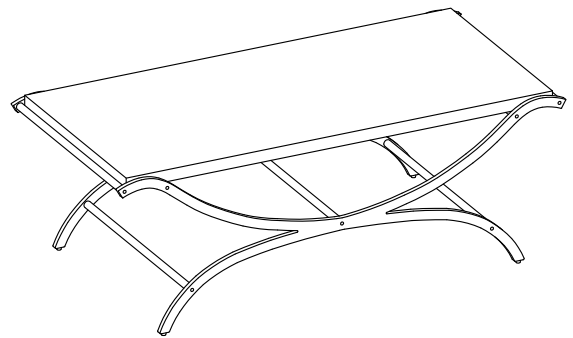
Item	Description	QTY
P1	Table Top 	1
P2	Side Frames 	2
P3	Support rails (with two holes) 	2
P4	Stretchers (without hole) 	5





Hardware List

Item	Description	QTY
H1	Short Bolts Ø1/4"*1"L 	14
H2	Long Bolts Ø1/4"*1-1/4"L 	4
H3	Allen Wrench 4mm 	1



Assembly Procedures:

Step 1. Assemble the table on a flat, soft surface such as a carpet or cloth to prevent scratching the finish. Loosely attach the support rails (P3) and stretchers (P4) to the side frames (P2) as shown below.

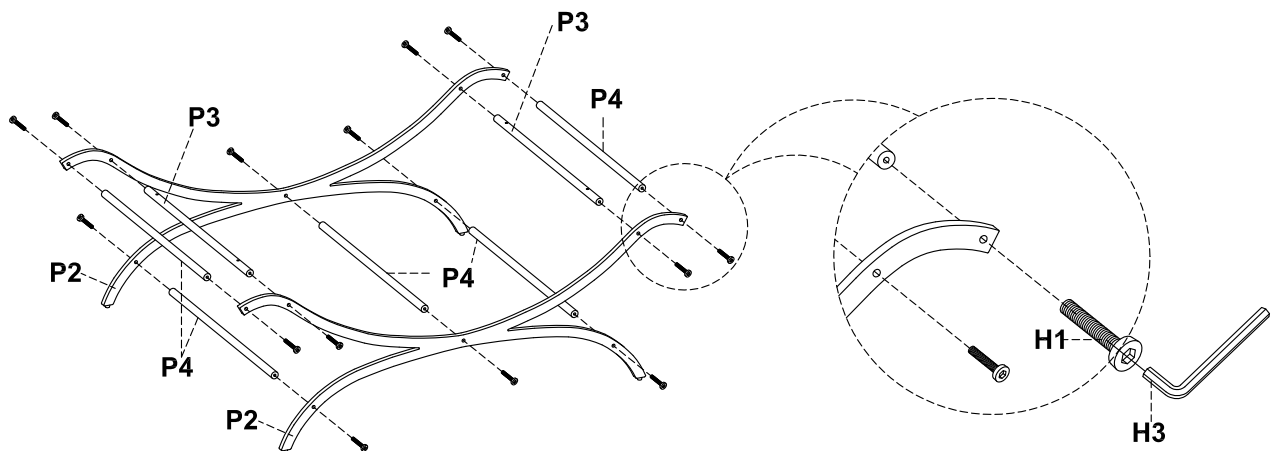
- (H1)x14 Short Bolts Ø1/4"*1" 
- (H3)x1 Allen Wrench 1/4" 



Step 2. Loosely attach the assembled support rails (P3) to the table top (P1) as shown below.

- (H2)x4 Long Bolts $\text{\O}1/4'' \times 1-1/4''$ 
(H3)x1 Allen Wrench 1/4" 

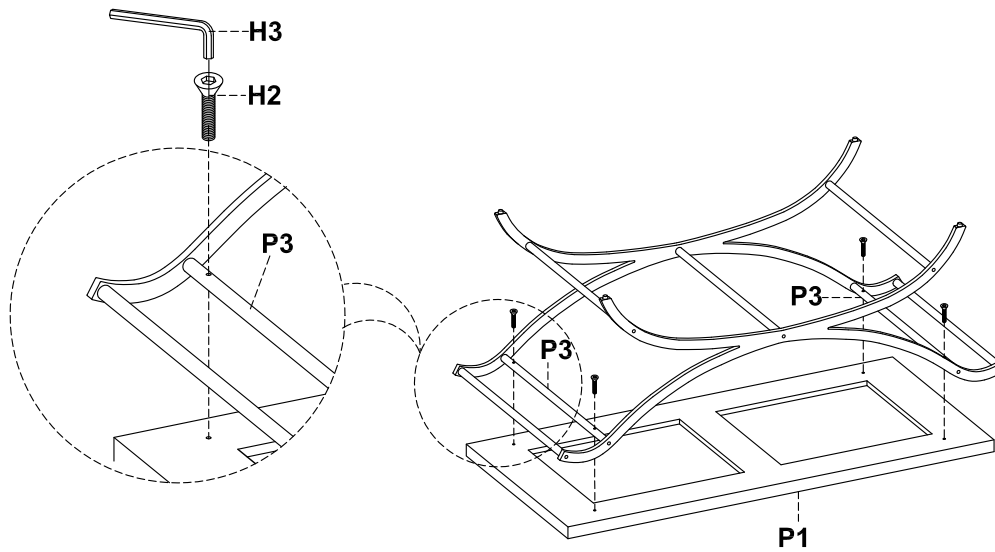

Step 3. Turn the assembled table to an upright position, make sure the table is level and aligned properly, then securely tighten all bolts with Allen wrench(H3). Assembly is complete. **Failure to follow these instructions may cause the bolts to misalign during assembly.**

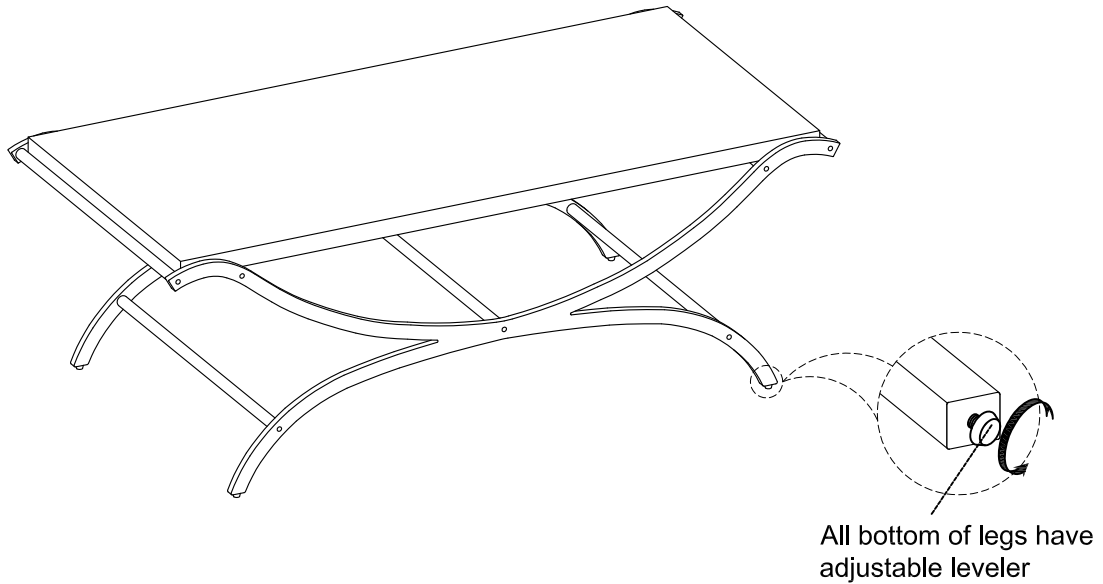

ADDITIONAL NOTE ABOUT SAFETY: BOLTS MAY LOOSEN DURING NORMAL EVERYDAY USE. THEY SHOULD BE PERIODICALLY INSPECTED AND RE-TIGHTENED TO PREVENT DAMAGE OR INJURY. ALWAYS CHECK TO ENSURE THAT ALL HARDWARE IS KEPT TIGHTENED.

Thank you for your purchase