







**Important safety instructions :**

- Please read carefully all instructions before assembly.
- For your safety and ease, assembly by two or more adults is recommended.
- Keep instructions for future use.

**Pre-assembly:**



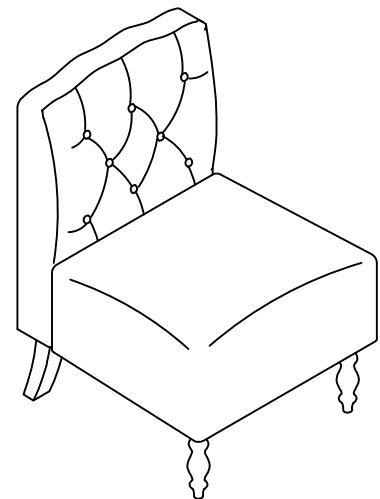

- Do not discard any contents until assembly is complete to avoid accidentally discarding small parts or hardware.
- Remove all parts and hardware from box along with any plastic protective packaging.

Hardware List

Item	Description		QTY
A	Short Bolts Ø5/16" x 2"		5
B	Long Bolts Ø5/16" x 3"		4
C	Flat Washers 5/16"		9
D	Lock Washers 5/16"		9
E	Plastic washer		2
F	Allen Wrench 5/16"		1

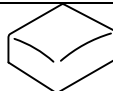

Parts List

Item	Description		QTY
G	Seat		1
H	Back Rest		1
i	Front Legs		2
J	Back Legs		2

**DISCLAIMER :**

**WHEN PROPERLY ASSEMBLED, THIS ITEM IS SAFE FOR INTENDED USE.  
SELLER IS NOT LIABLE FOR ANY DAMAGES RESULTING FROM ITEM BEING IMPROPERLY ASSEMBLED AFTER PURCHASE.**

## Assembly Procedures:

### Step 1

Attach front legs ( i ) to chair seat ( G ) using bolts ( B ), lock washers ( D ) and flat washers ( C ).  
Loosely tighten the bolts with Allen wrench ( F ) .

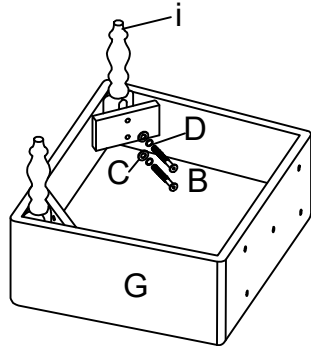

### Step 2:

Attach seat cushion ( G ) to back rest ( H ) using bolts ( A ), lock washers ( D ) and flat washers ( C ).  
Loosely tighten the bolts with Allen wrench ( F ) .

### Step 3:

Attach back leg ( J ) to back rest ( H ) . Place on plastic washer ( E ) to back panel hole. Rotate the back legs clockwise until fully tighten.

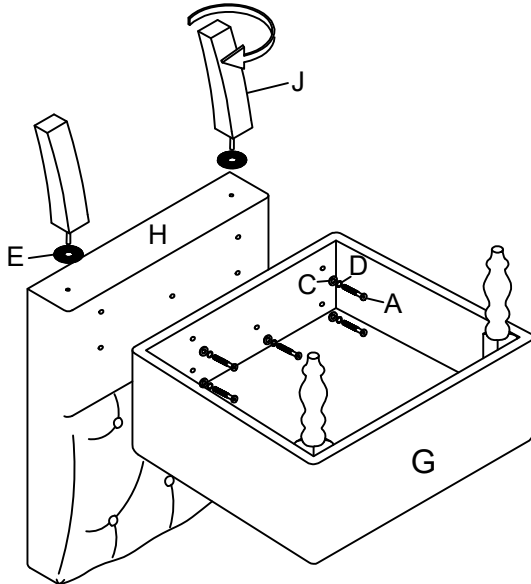

### Step 4:

Fully tighten all bolts . Assembly is complete.

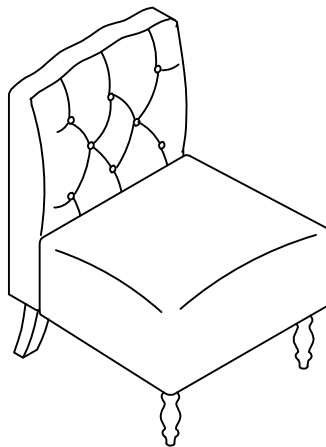

#### ADDITIONAL NOTE ABOUT SAFETY :

**BOLTS MAY LOOSEN DURING NORMAL EVERYDAY USE.**

**THEY SHOULD BE INSPECTED AT LEAST EVERY 3 MONTHS AND RE-TIGHTENED AS NEEDED TO PREVENT DAMAGE OR INJURY AND ENSURE STABILITY.**