



# ASSEMBLY INSTRUCTIONS

Description: Cedric Accent Ottoman





## Important safety instructions:

- Please read carefully all instructions before assembly.
- For your safety and ease, assembly by two or more adults is recommended.
- Keep instructions for future use.

## Pre-assembly:



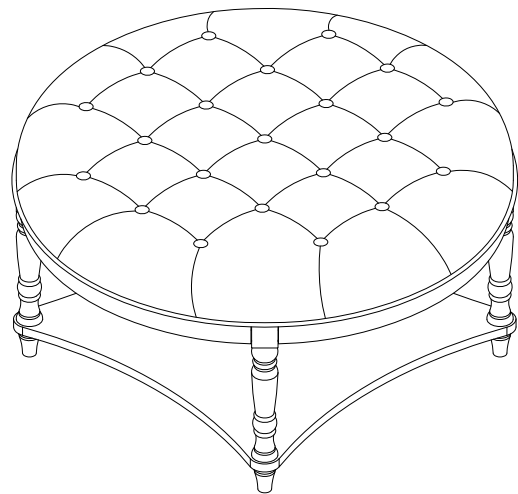

- Do not discard any content until assembly is complete to avoid accidentally discarding small parts or hardware.
- Take out all parts and hardware from box.

## Parts List

Item	Description	QTY
P1	Seat Cushion 	1
P2	Posts 	4
P3	Shelf 	1
P4	Feet 	4



## Hardware List

Item	Description	QTY
H1	Bolts Ø5/16" * 2"L 	4
H2	Lock Washers Ø5/16" 	4
H3	Flat Washers Ø5/16" 	4
H4	Allen Wrench 5/16" 	1

## DISCLAIMER:

WHEN PROPERLY ASSEMBLED, THIS ITEM IS SAFE FOR INTENDED USE. SELLER IS NOT LIABLE FOR ANY DAMAGES RESULTING FROM ITEM BEING IMPROPERLY ASSEMBLED AFTER PURCHASE.

## Assembly Procedures:

Step 1. Assemble the ottoman on a flat, soft surface such as a carpet or cloth to prevent scratching the finish. Take out the posts (P2) and feet (P4) from the legs box, then unscrew each foot (P4) from each post (P2) as shown below.

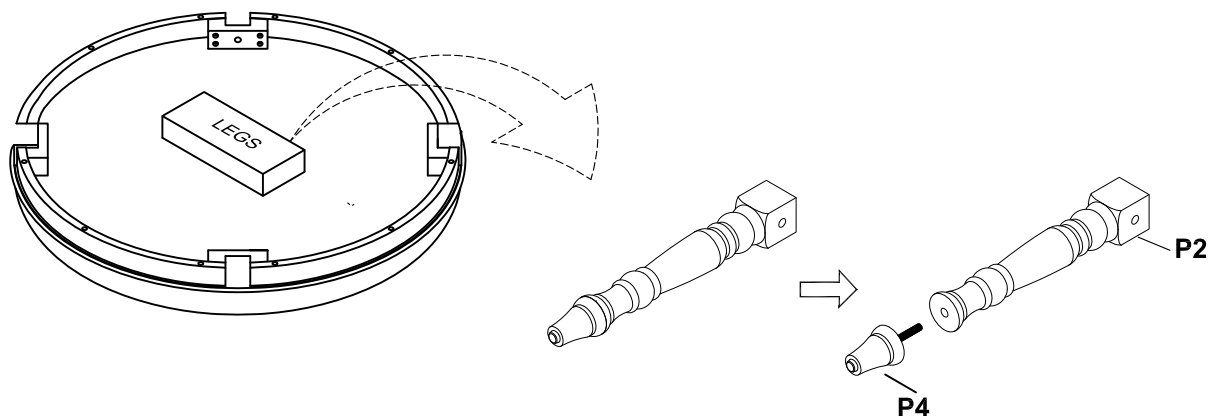

Step 2. Attach each post (P2) to the bottom of seat cushion (P1) using bolts (H1), lock washers (H2) and flat washers (H3) as shown below.

- |        |              |   |
|--------|--------------|---|
| (H1)x4 | Bolts        |  |
| (H2)x4 | Lock Washers |  |
| (H3)x4 | Flat Washers |  |
| (H4)x1 | Allen Wrench |  |

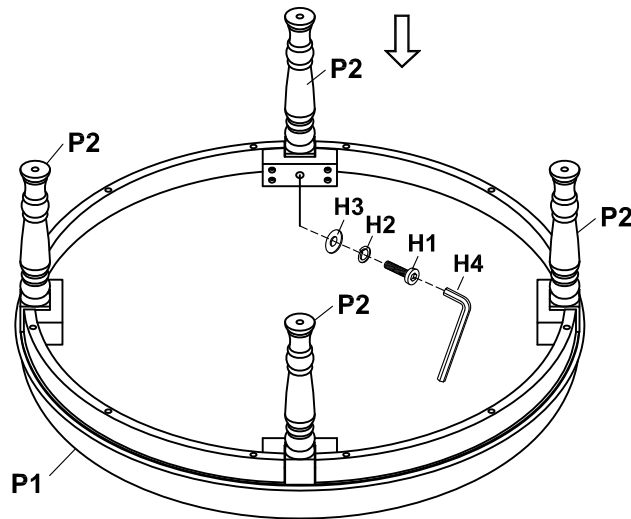

### Step 3.

- 1) Attach the feet (P4) to the posts (P2) through the shelf (P3) as shown below. Securely tighten the feet (P4).
- 2) Turn the assembled table to an upright position.
- 3) Make sure the ottoman is level and securely tighten all the bolts with Allen wrench (H4).
- 4) Assembly is complete.

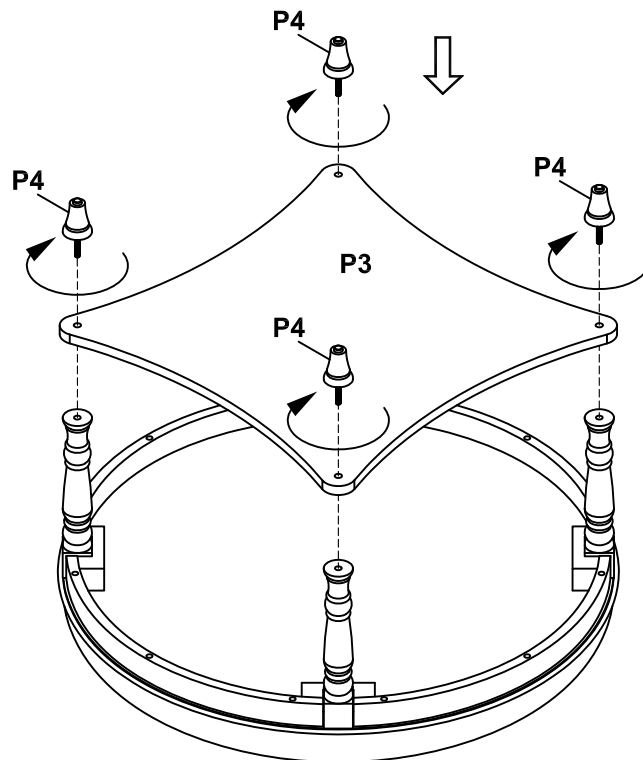

**Caution:** Failure to follow these instructions may cause the bolts to misalign during assembly.

#### ADDITIONAL NOTE ABOUT SAFETY:

**BOLTS MAY LOOSEN DURING NORMAL EVERYDAY USE.**

**THEY SHOULD BE INSPECTED AT LEAST EVERY 3 MONTHS AND RE-TIGHTENED AS NEEDED TO PREVENT DAMAGE OR INJURY, AND ENSURE STABILITY.**

Thank you for your purchase