

ASSEMBLY INSTRUCTIONS

MONROE CAMEL BACK EXPOSED WOOD CHAIR

MADISON PARK®

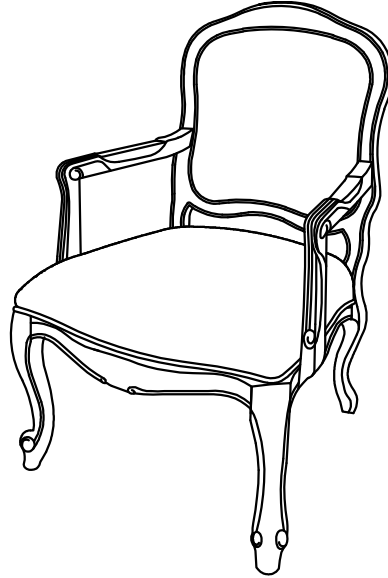



Please read below before assembly

- Assemble the product on a flat, soft surface such as a carpet or cloth to prevent scratching the finish.
- Do not discard any content until assembly is complete to avoid accidentally discarding small parts or hardware.
- Take out all parts and hardware from box.
- Failure to follow these instructions may cause the bolts to misalign during assembly.

DISCLAIMERS:

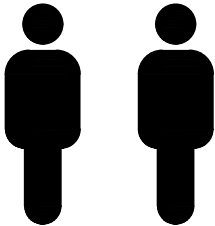





- WHEN PROPERLY ASSEMBLED, THIS ITEM IS SAFE FOR INTENDED USE. SELLER IS NOT LIABLE FOR ANY DAMAGES RESULTING FROM ITEM BEING IMPROPERLY ASSEMBLED AFTER PURCHASE.
- BOLTS MAY LOOSEN DURING NORMAL EVERYDAY USE. THEY SHOULD BE INSPECTED AT LEAST EVERY 3 MONTHS AND RE-TIGHTENED AS NEEDED TO PREVENT DAMAGE OR INJURY, AND ENSURE STABILITY.

| | | |
|--|--|--|
|  PEOPLE NEEDED |  300 lbs seat WEIGHT LIMIT |  15 Minutes ESTIMATED TIME |
|--|--|--|

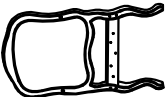
TOOLS REQUIRED (NOT INCLUDED)



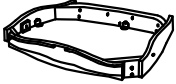



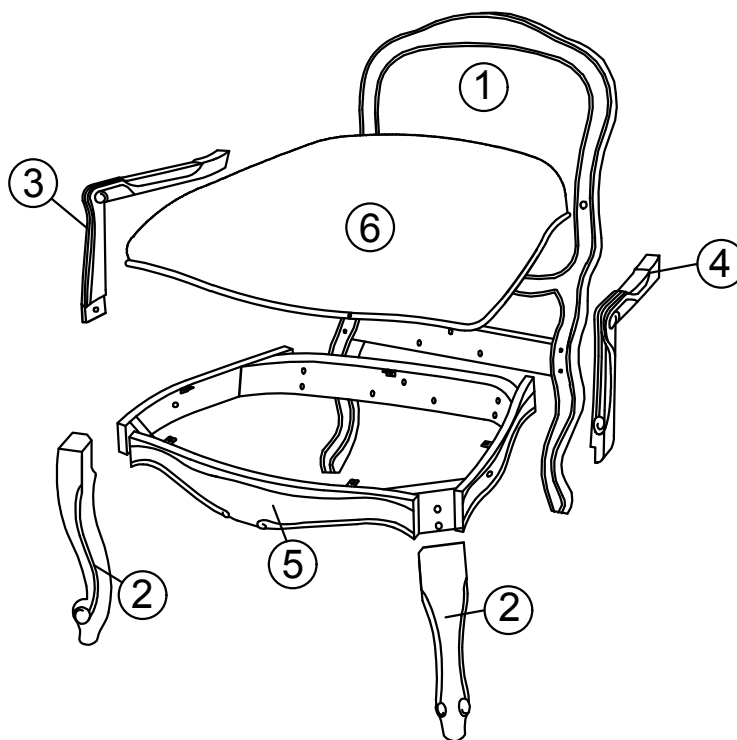

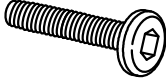

| | |
|---|---|
|  PHILLIPS HEAD SCREW DRIVER |  RUBBER Mallet |
|---|---|

PARTS LIST

| | | | |
|---|--------------|--|-------|
| ① | CHAIR BACK |  | 1 PC |
| ② | FRONT LEG |  | 2 PCS |
| ③ | LEFT ARM |  | 1 PC |
| ④ | RIGHT ARM |  | 1 PC |
| ⑤ | SEAT FRAME |  | 1 PC |
| ⑥ | SEAT CUSHION |  | 1 PC |

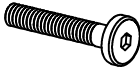
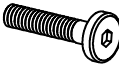

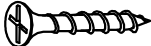

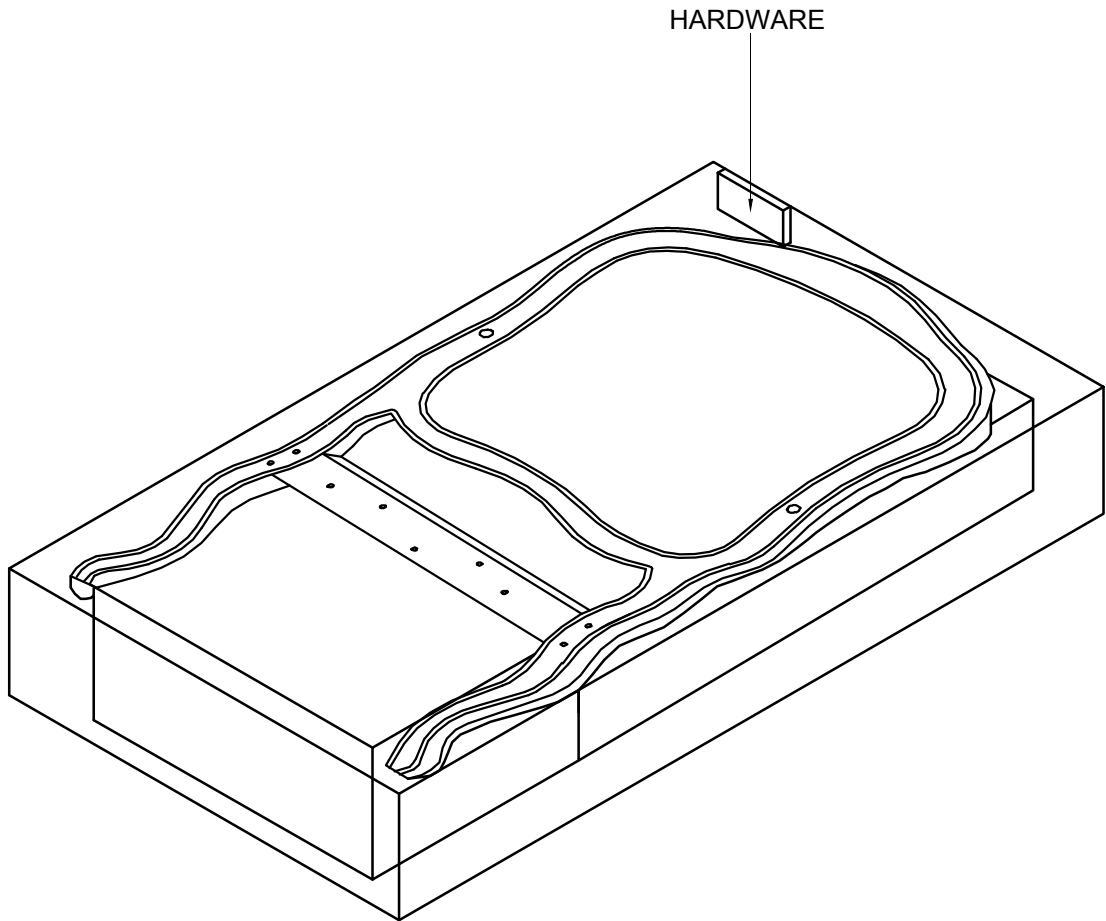

HARDWARE LIST

| | | | |
|---|-----------------------------------|---|--------|
| A | LARGE LONG BOLT Ø5/16" x 3" |  | 4 PCS |
| B | LARGE MEDIUM BOLT Ø5/16" x 2-1/2" |  | 4 PCS |
| C | LARGE SHORT BOLT Ø5/16" x 1-3/4" |  | 3 PCS |
| D | LARGE LOCK WASHER Ø5/16" |  | 13 PCS |
| E | LARGE FLAT WASHER Ø5/16" |  | 13 PCS |
| F | ALLEN KEY |  | 1 PC |
| G | SMALL LONG BOLT Ø1/4" x 1-3/4" |  | 2 PCS |
| H | SMALL SHORT BOLT Ø1/4" x 1-1/2" |  | 2 PCS |
| I | SMALL LOCK WASHER Ø1/4" |  | 2 PCS |
| J | SMALL FLAT WASHER Ø1/4" x 5/8" |  | 2 PCS |
| K | SCREW Ø1/8" x 3/4" |  | 5 PCS |
| L | WOODEN PLUG |  | 2 PCS |

STEP 1 LOCATE PARTS AND HARDWARE PER BELOW DRAWING

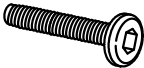



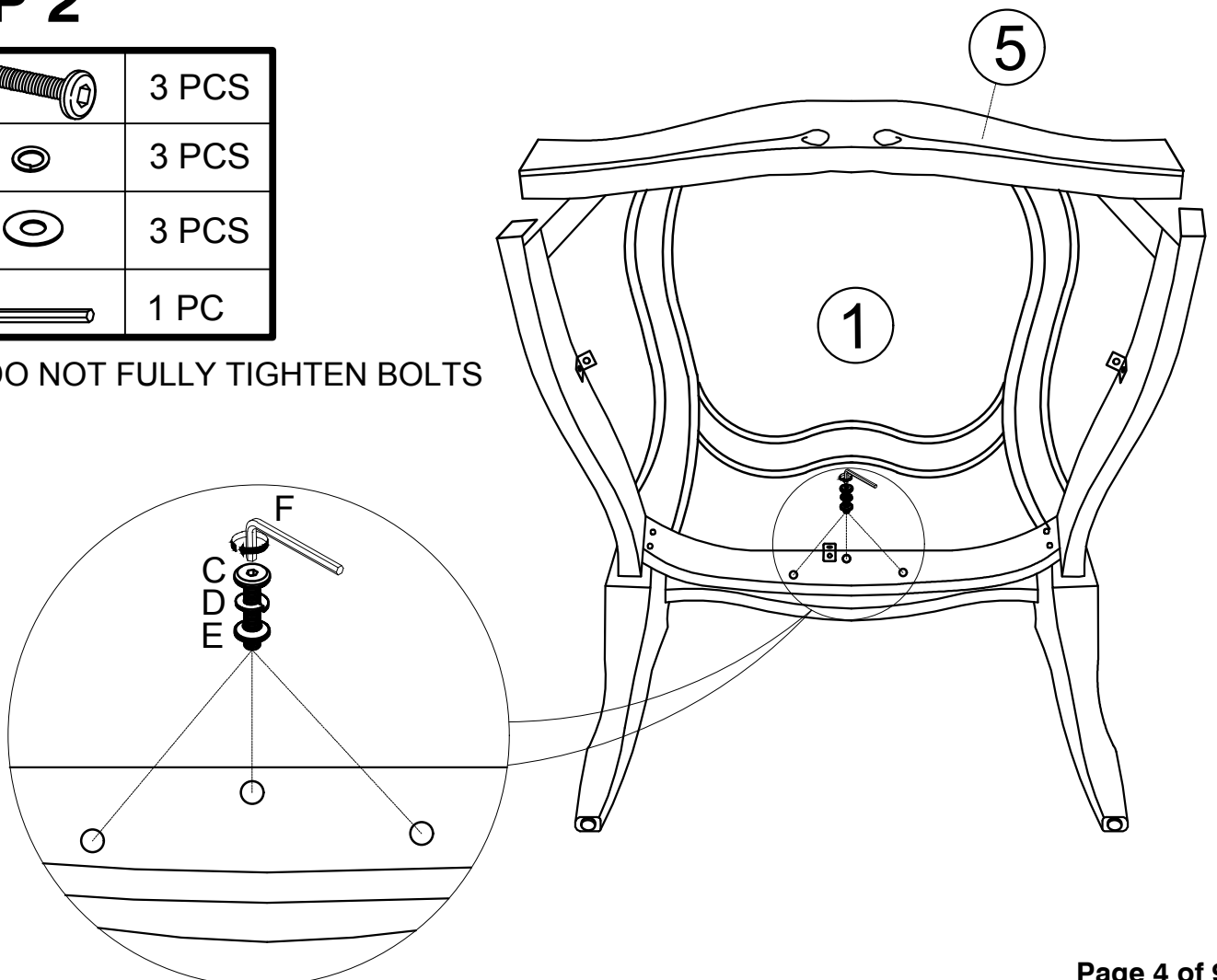

STEP 2

| | | |
|---|---|-------|
| C |  | 3 PCS |
| D |  | 3 PCS |
| E |  | 3 PCS |
| F |  | 1 PC |

NOTE: DO NOT FULLY TIGHTEN BOLTS





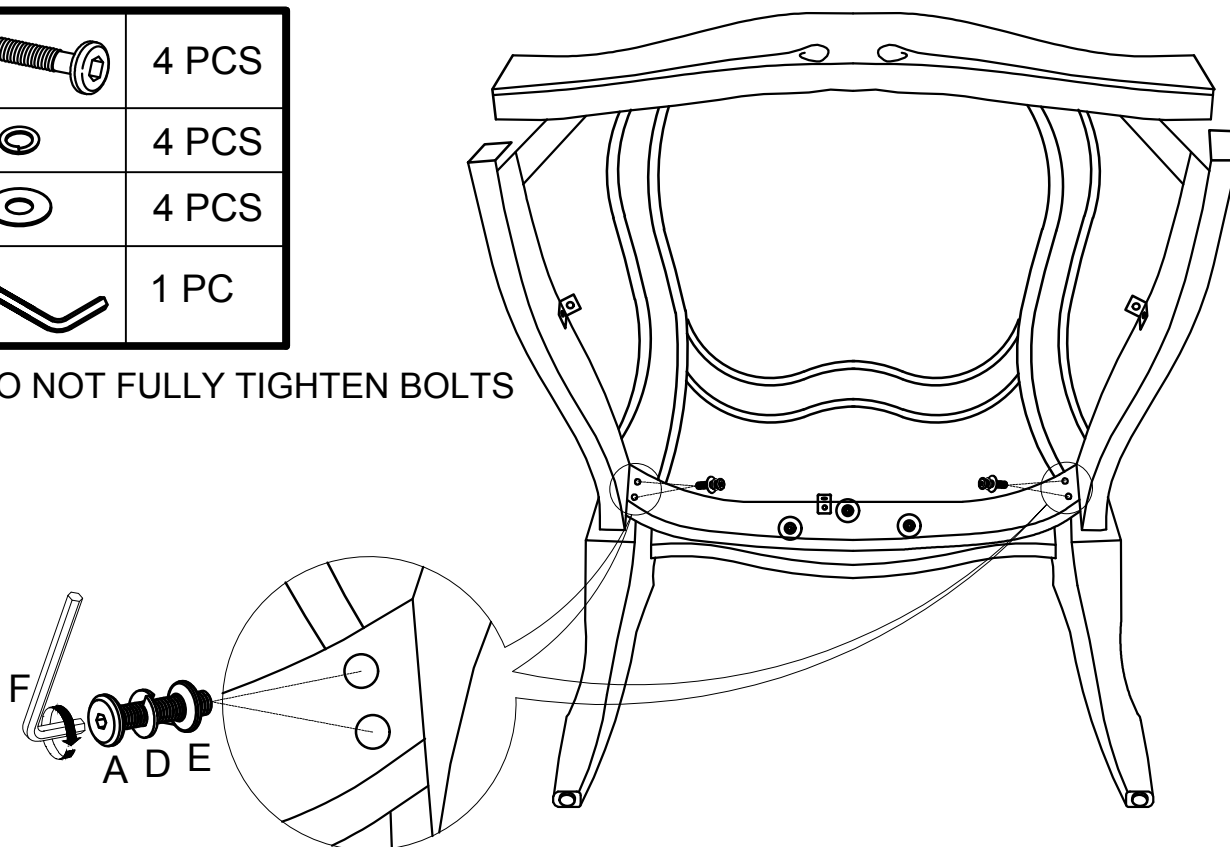

STEP 3

| | | |
|---|---|-------|
| A |  | 4 PCS |
| D |  | 4 PCS |
| E |  | 4 PCS |
| F |  | 1 PC |

NOTE: DO NOT FULLY TIGHTEN BOLTS





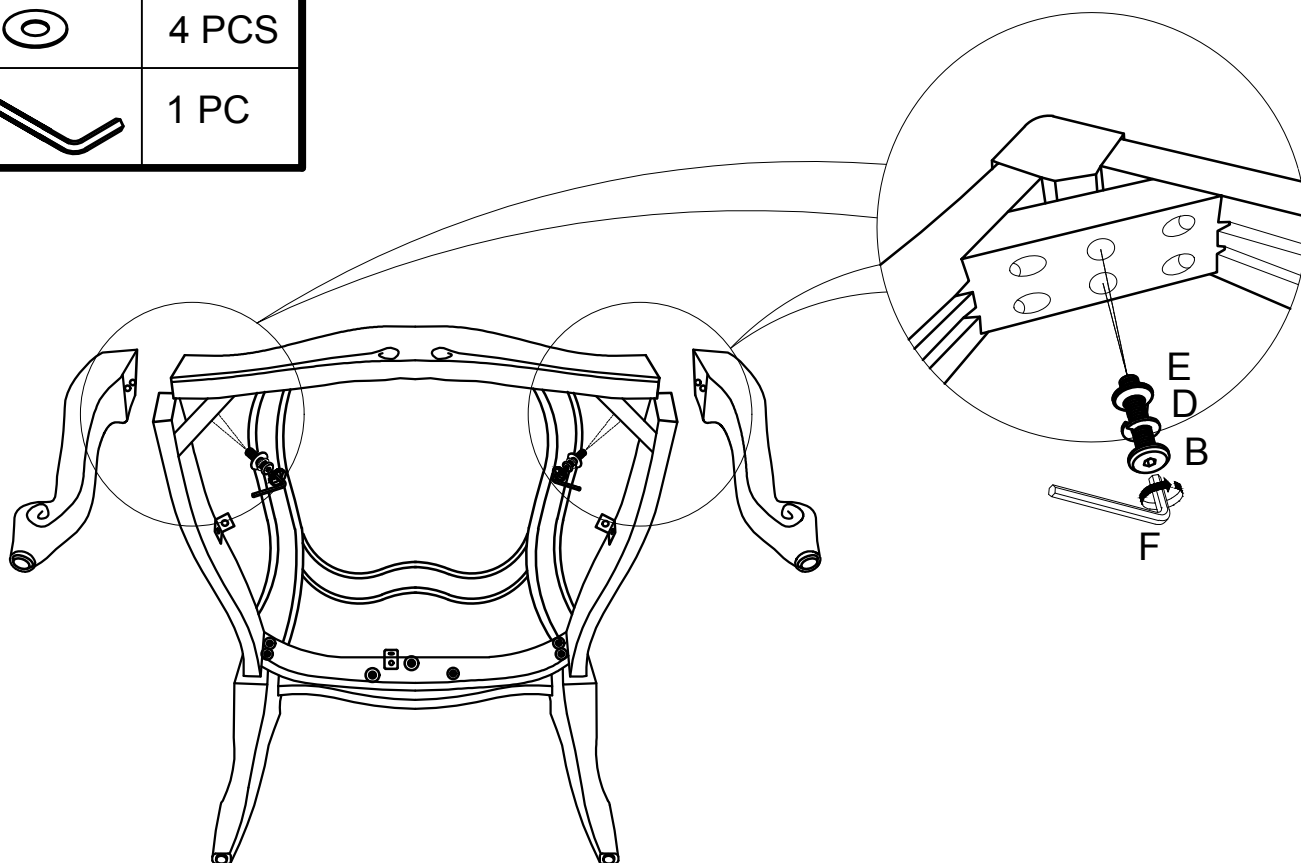

STEP 4

| | | |
|---|---|-------|
| B |  | 4 PCS |
| D |  | 4 PCS |
| E |  | 4 PCS |
| F |  | 1 PC |

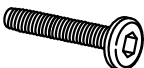



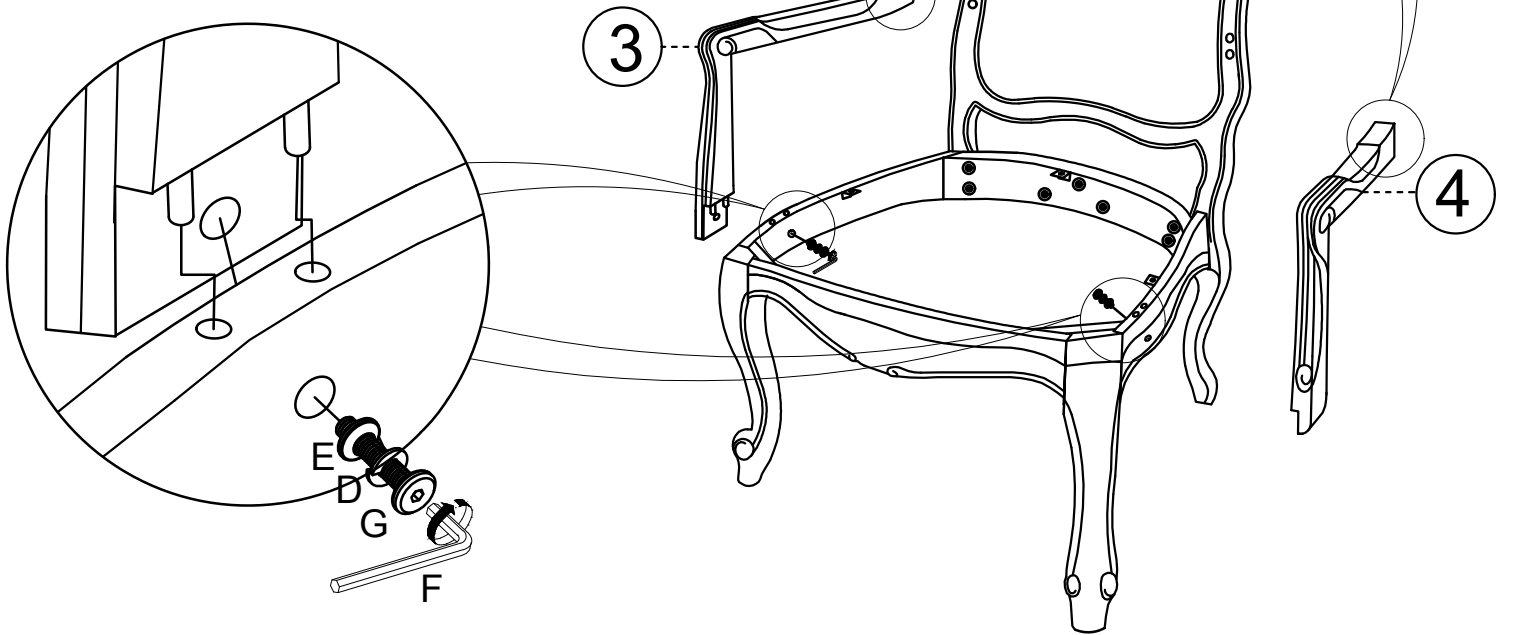

STEP 5

| | | |
|---|---|-------|
| G |  | 2 PCS |
| D |  | 2 PCS |
| E |  | 2 PCS |
| F |  | 1 PC |

NOTE: DO NOT FULLY TIGHTEN BOLTS



STEP 6

| | | |
|---|---|-------|
| H |  | 2 PCS |
| I |  | 2 PCS |
| J |  | 2 PCS |
| F |  | 1 PC |

NOTE: PLEASE TIGHTEN ALL BOLTS

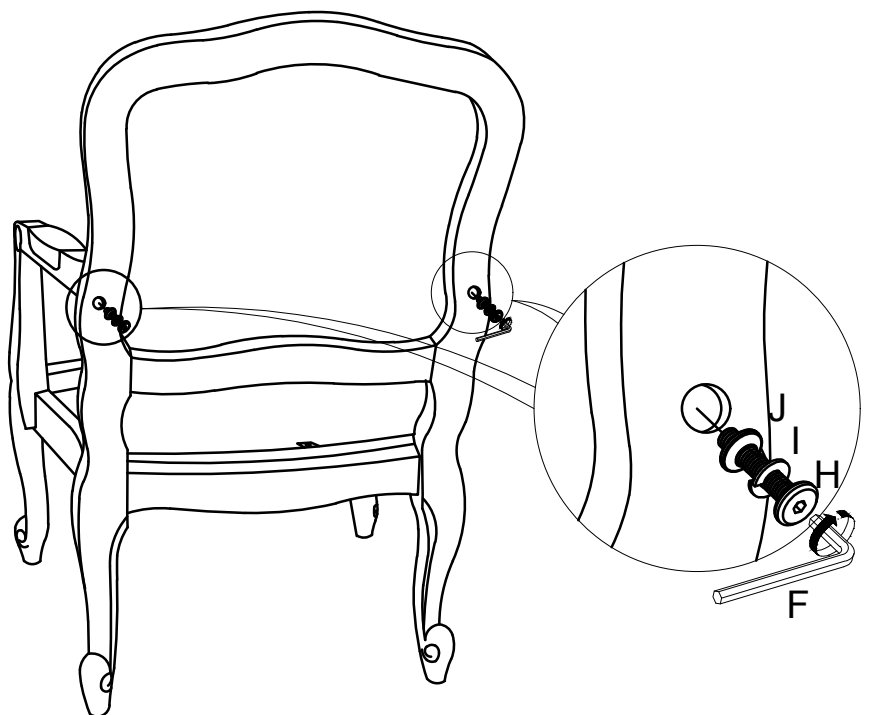

STEP 7

| | | |
|---|---|-------|
| L |  | 2 PCS |
|---|---|-------|

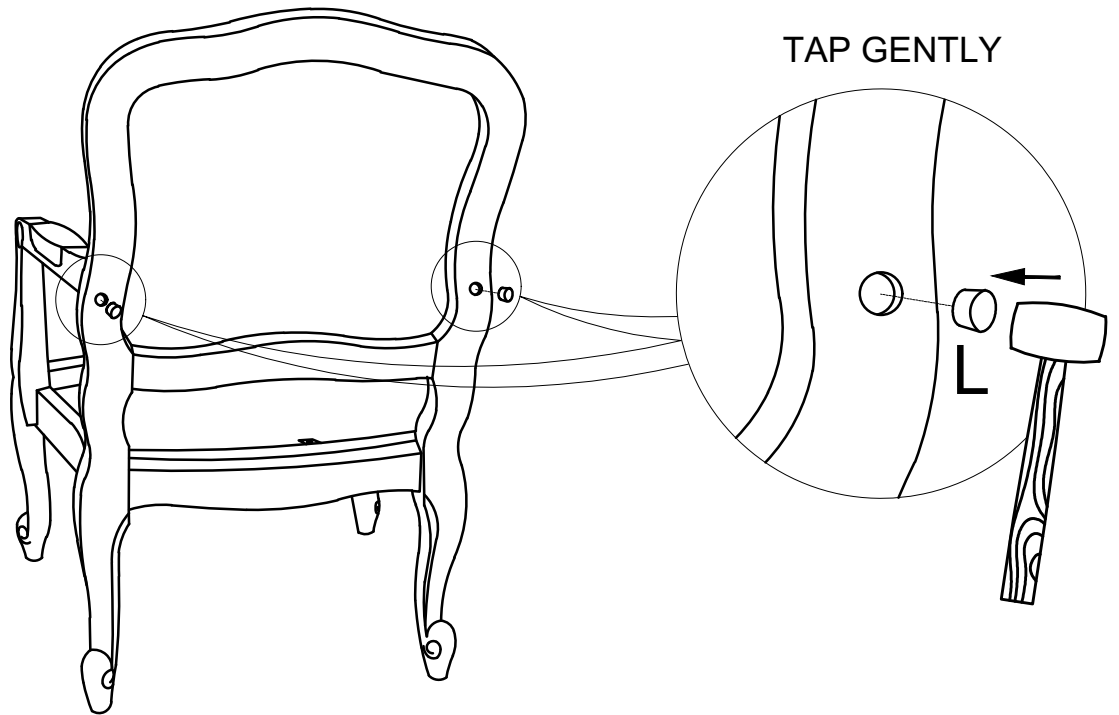

STEP 8

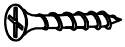
| | | |
|---|---|-------|
| K |  | 5 PCS |
|---|---|-------|

* PLEASE FLIP OVER THE CHAIR.

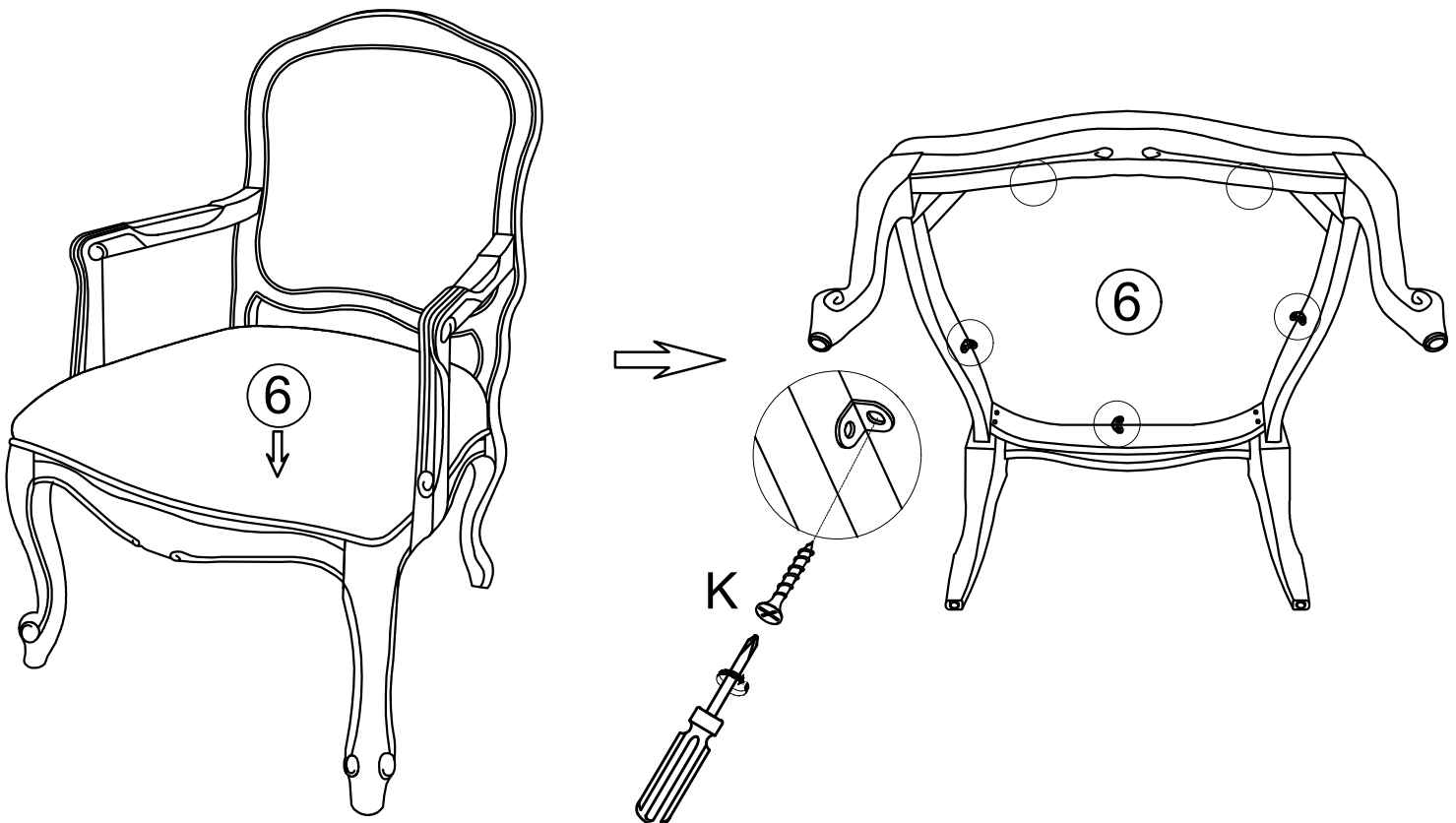

STEP 9

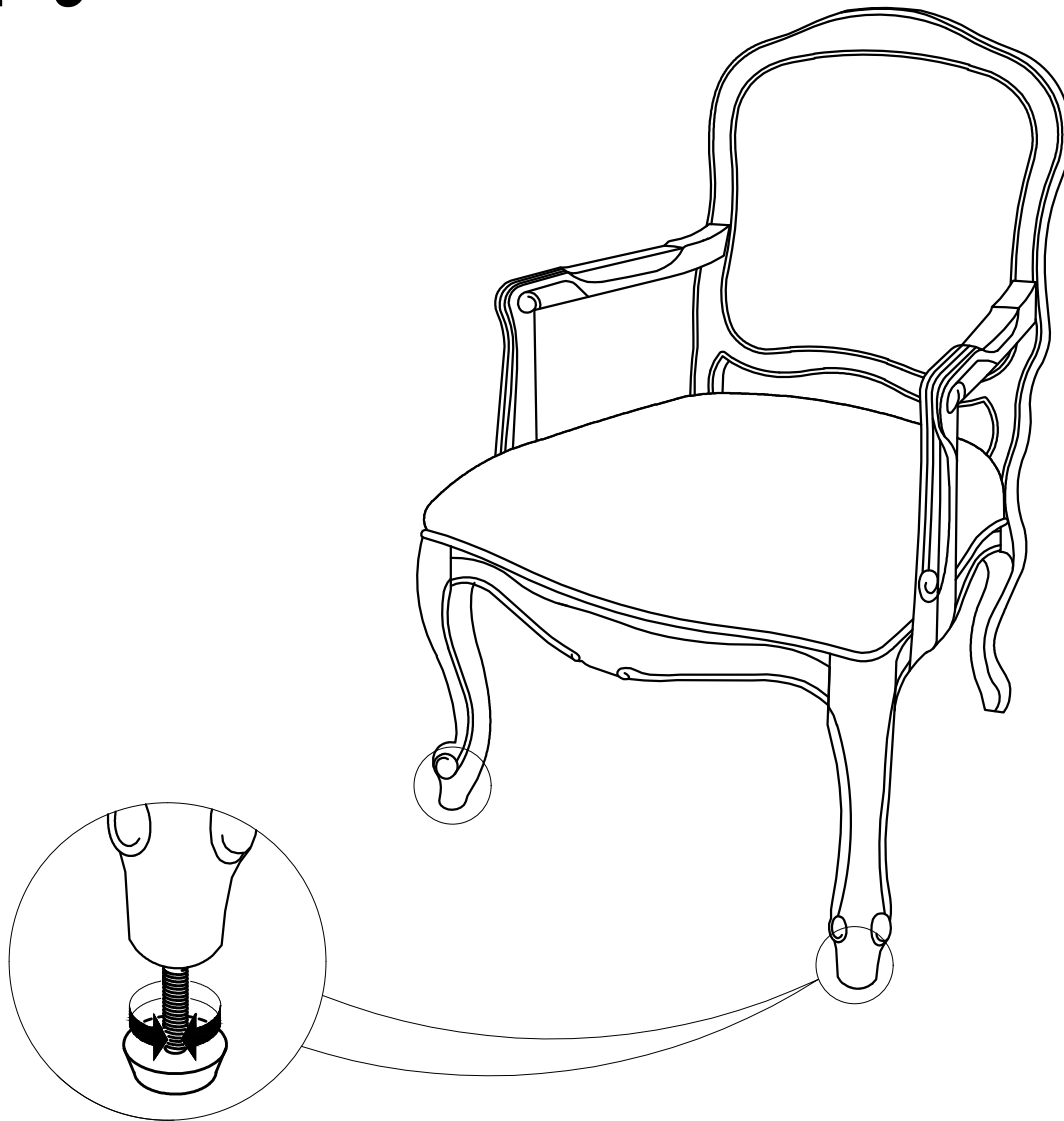

ADJUST LEVELERS
FOR UNEVEN FLOOR

Care & Maintenance

Do...



Wipe up spills immediately.



Dust and pick-up spills using a clean, non-colored, lint-free, dry cloth.



Use mild non-abrasive soap and water.

Don't...



Do not put hot items directly on furniture surface.



Do not clean furniture with harsh cleansers or polish.

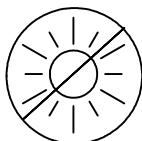

Do not place furniture in direct sunlight.



Do not place furniture near heating or cooling vents.



Do not write on furniture without a padded barrier to protect the surface.



Do not place furniture outside. For indoor use only.