















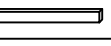

ASSEMBLY INSTRUCTION

91-0376 CHAIR

| PARTS LIST | | | | | | | |
|------------|-------------------------|---|-------|--------|------------------------|---|-------|
| PARTS# | Description | Pattern | Q'ty | PARTS# | Description | Pattern | Q'ty |
| A | Bolt DiaØ1/4"×2" |  | 12PCS | K | Lock Washer Ø1/4"×12mm |  | 12PCS |
| B | Bolt DiaØ5/16"×2" |  | 4PCS | L | Chair Back |  | 1PC |
| C | Flat Washer Ø5/16"×19mm |  | 4PCS | M | Left side frame |  | 1PC |
| D | Lock Washer Ø5/16"×12mm |  | 4PCS | N | Right side frame |  | 1PC |
| E | Wood Screw (#8×5/8") |  | 8PCS | O | Front rail |  | 1PC |
| F | Allen Wrench 4mm |  | 1PC | P | Bottom rail |  | 1PC |
| G | Wood Plug Ø20mm |  | 2PCS | Q | Rocker runner |  | 2PCS |
| H | Wood Plug Ø14mm |  | 10PCS | R | Seat cushion |  | 1PC |
| I | L bracket | | 4PCS | S | Allen Wrench 5mm |  | 1PC |
| J | Flat Washer Ø1/4"×16mm |  | 2PCS | | | | |

STEP 1.

Remove all parts from carton and separate them into part number groups as indicated on the parts list. Loosely tighten all bolts until instructed to fully tighten at the end of step 5. Attach bottom rail (P) to side frame (M+N) using bolts, Lock washer washers (A+K) with allen wrench (F) for both L&R side, Don't tighten yet.

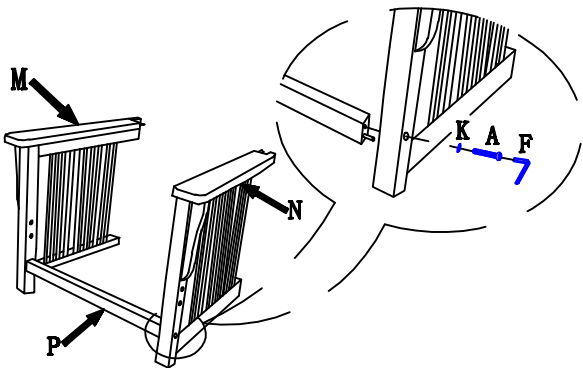

STEP 2.

Attach front rail (O) to side frame (M+N) using bolts, lock washers (A+K) with allen wrench (F) for both L&R side, Don't tighten yet.

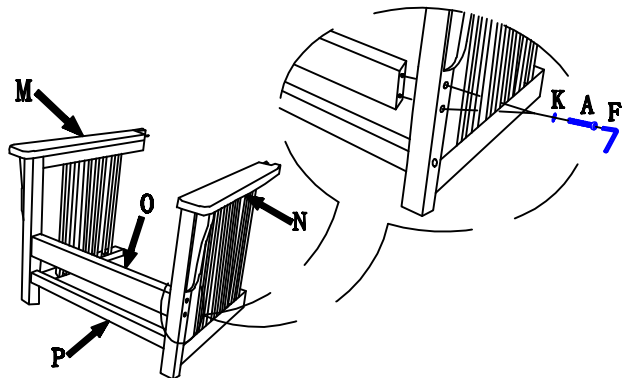

STEP 3.

Assemble side frame (M+N) to chair back (L) using bolts, lock washer (A+K) and flat washer (A+K+J) with allen wrench (F) for both L&R side. Don't tighten yet.

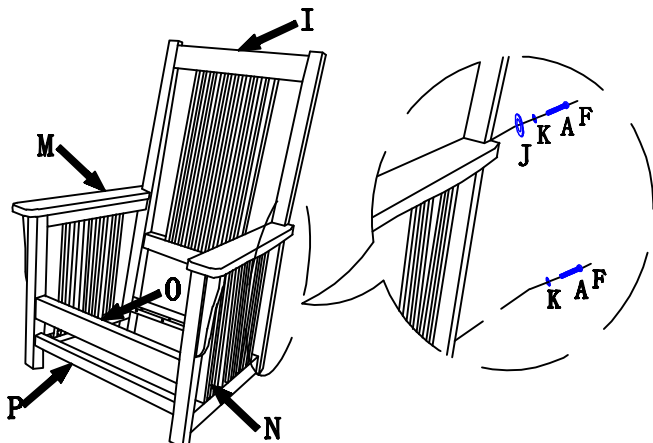

STEP 4.

Assemble rocker runner (Q) to the side frame (M+N) using bolts, lock washer, flat washers (B+D+C) with allen wrench (S) at the bottom of the rocker runner for both L&R side. Don't tighten yet.

